



Technical Information

C23-SATA

Mezzanine I/O Expansion Board

PCIe to SATA RAID Controller

Document No. 5208 • Ed. 2 • 2009-03

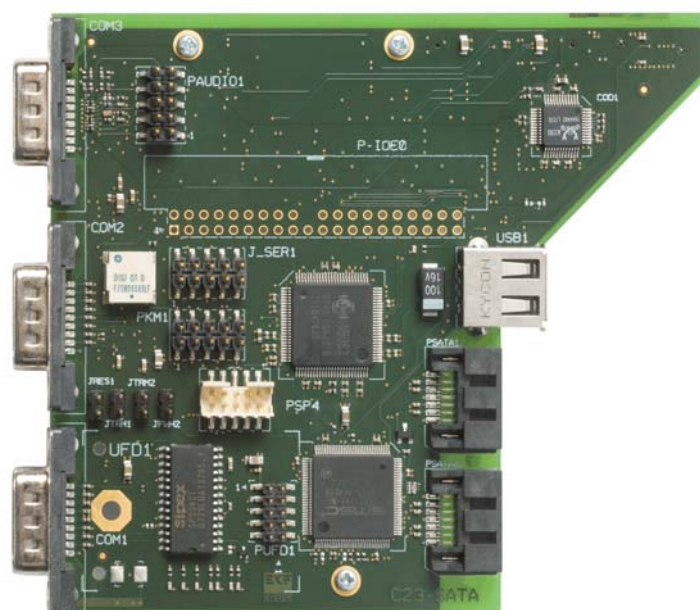

Contents

| | |
|--|----|
| About this Manual | 4 |
| Edition History | 4 |
| Related Documents | 5 |
| Nomenclature | 5 |
| Trade Marks | 5 |
| Legal Disclaimer - Liability Exclusion | 5 |
| Standards | 6 |
| C23-SATA Features | 7 |
| Feature Summary | 7 |
| Short Description | 9 |
| Front Panel | 11 |
| Block Diagram C23-SATA | 12 |
| Top View Component Assembly C23-SATA | 14 |
| Front Panel Connectors | 16 |
| On-Board Connectors | 16 |
| Jumpers | 17 |
| Inter-Board Connectors | 17 |
| Installing and Replacing Components | 18 |
| Before You Begin | 18 |
| Warnings | 18 |
| Caution | 18 |
| Installing the Board | 19 |
| Removing the Board | 20 |
| EMC Recommendations | 21 |
| Technical Reference - Connectors | 22 |
| Caution | 22 |
| Please Note | 22 |
| Front Panel Connectors | 23 |
| COM-A (RS-232/RS-485) | 24 |
| COM-B COM-C (RS-232) | 26 |
| Audio Connector | 27 |
| On-Board Connectors | 28 |
| P-AUDIO | 29 |
| P-IDE | 30 |
| P-KM | 31 |
| P-SATA0 P-SATA1 | 31 |
| P-SP4 | 32 |
| P-UFD | 34 |
| P-USB | 35 |
| On-Board Jumpers | 36 |
| J-RES | 36 |
| J-FWH2 | 36 |
| J-SER | 36 |
| J-TRM1 J-TRM2 | 36 |
| Inter-Board Connectors | 37 |
| P-EXP | 39 |
| P-PCIE | 40 |

| | |
|-------------------------------|----|
| Additional Functions | 42 |
| Firmware Hub 2 | 42 |
| SMBus EEPROM | 42 |
| Trusted Platform Module | 43 |
| Schematics | 44 |

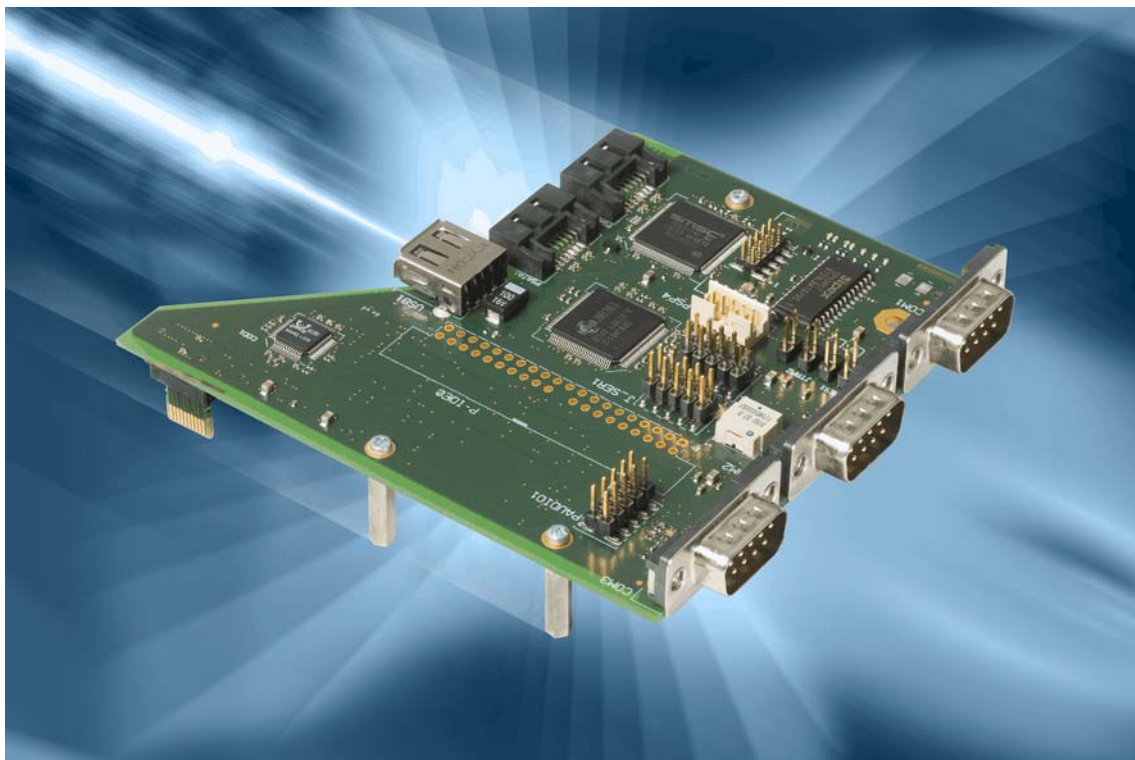

About this Manual

This manual is a short form description of the technical aspects of the C23-SATA, required for installation and system integration. It is intended for the advanced user only.

Edition History

| EKF Document | Ed. | Contents/Changes | Author | Date |
|----------------------------|-----|--|--------|---------------|
| Text # 5208 c23_tie.wpd | 1 | Technical Information C23-SATA English, Preliminary Edition | jj | 21 July 2008 |
| | 2 | Audio Codec is either AC'97 or HD Audio (stuffing option) | jj | 16 March 2009 |
| | | | | |
| | | | | |
| | | | | |
| | | | | |
| | | | | |

Related Documents

For a description of the CCG-RUMBA CPU card, which acts as carrier board with respect to the C23-SATA, please refer to the correspondent CPU user guide, available by download from www.ekf.com/c/ccpu/ccg/ccg_e.html (change path accordingly for other possible CPU carrier boards).

Nomenclature

Signal names used herein with an attached '#' designate active low lines.

Trade Marks

Some terms used herein are property of their respective owners, e.g.

- ▶ Intel, Pentium, Celeron, Core 2 Duo, Merom, Penryn, iAMT: ® Intel
- ▶ Santa Rosa Platform, Crestline Chipset GM965: Intel
- ▶ Montevina Platform, Cantiga Chipset GS45: Intel
- ▶ **CompactPCI**® : ® PICMG
- ▶ Windows 2000, Windows XP, Windows Vista: ® Microsoft
- ▶ EKF, ekf system: ® EKF

EKF does not claim this list to be complete.

Legal Disclaimer - Liability Exclusion

This manual has been edited as carefully as possible. We apologize for any potential mistake. Information provided herein is designated exclusively to the proficient user (system integrator, engineer). EKF can accept no responsibility for any damage caused by the use of this manual.

Standards

| Specifications/Standards | |
|--------------------------|--|
| PCI Express | PCIe Base Spec. 1.1 and other (PCI SIG www.pcisig.com) |
| SATA | Serial ATA 2.5/2.6 Specification (www.sata-io.org) |
| USB | Universal Serial Bus Revision 2.0 specification (www.usb.org/developers) |
| TPM | Trusted Platform Module 1.2 (https://www.trustedcomputinggroup.org) |
| AC'97 Audio | Audio Codec '97 Revision 2.3 April 2002 (Intel®) |
| HD Audio | High Definition Audio Specification Rev.1.0 http://www.intel.com/design/chipsets/hdaudio.htm |

C23-SATA Features

Feature Summary

| Feature Summary | |
|---|--|
| Form Factor | Single size cropped Eurocard (112x100mm ²), needs 4HP (20.3mm) mounting space in addition to CPU carrier board, typically delivered as a ready to use assembly unit (including the CCG-RUMBA or successor CPU card), provided with a common 8HP front panel shared with the CPU board, mounting position right (on top of CPU board) |
| SATA/PATA ³ | <ul style="list-style-type: none"> ▶ JMB363 PCIe to 2 x SATA II / 1 x PATA controller ▶ RAID level 0/1 capable, drivers RAID or non-RAID ▶ SATA/PATA connectors for system internal usage |
| LPC Super-I/O ³ (SIO2) | <ul style="list-style-type: none"> ▶ SCH3114, 4 serial ports, PS/2 keyboard & mouse port ▶ Up to three serial COM ports RS-232 available from the front panel (9-position male D-Sub connectors) ▶ COM-A configurable as either RS-232 or RS-485 compliant ▶ COM-B & COM-C conform to RS-232 ▶ COM-C may be replaced by Audio I/O female D-Sub connector (option) ▶ SP4 available for attachment of an EKF CU-Series PHY module (TTL-level COM-Port on 10-position pin header) |
| Firmware Hub ³ (FWH2) | <ul style="list-style-type: none"> ▶ 82802 generic device, 8Mbit Flash, LPC interface ▶ Can be configured (jumper) as secondary or primary (boot code) FWH |
| TPM ³ | <ul style="list-style-type: none"> ▶ Option Trusted Platform Module cryptographic chip according to TPM 1.2 ▶ Infineon or Atmel brand (standard footprint) |
| Audio Codec ^{2, 3} | <ul style="list-style-type: none"> ▶ Option AC'97 audio codec ALC203 ▶ Alternate Option HD Audio Codec ALC262 ▶ Realtek driver available ▶ On-board 10-position pin header ▶ Option front panel audio connector (replaces COM-C) |
| Front Panel Connectors ¹ | <ul style="list-style-type: none"> ▶ 3 x COM port connectors (9-position male D-Sub) COM-A COM-B COM-C ▶ Option Audio connector (9-position female D-Sub), replaces COM-C |
| Host I/F Connectors (to CPU Carrier) ¹ | <ul style="list-style-type: none"> ▶ PCI Express interface (PCIe x 1) high speed connector ▶ Multifunction expansion interface (LPC, USB, SMB) |
| On-Board I/O Connectors ¹ | <ul style="list-style-type: none"> ▶ Option PATA (IDE) 40-position pin header, horizontal oder vertical ▶ 2 x Latched SATA headers 7-pos. ▶ Option PS/2 keyboard/mouse 10-position pin header ▶ USB receptacle for system internal usage ▶ Option pin header suitable for low profile USB Solid State Drive (SSD) module ▶ Option serial port header (TTL-level) ▶ Option Audio I/O 10-position pin header ▶ Reset |
| On-Board Jumpers ¹ | <ul style="list-style-type: none"> ▶ Reset ▶ Firmware Hub selection ▶ COM-A configuration RS-232 or RS-485 ▶ RS-485 Termination resistors |
| On-Board Functions | Speaker, LEDs, SMBus EEPROM, temperature sensors |

| | |
|---------------------------------------|---|
| Mass Storage Options | <ul style="list-style-type: none"> ▶ Up to 2 system internal PATA/IDE drives configured as master/slave attached by flat cable harness ▶ Up to 2 system internal SATA drives optionally attached to SATA headers via cable assembly ▶ USB Solid State Drive (SSD) module option ▶ USB drive attached to USB connector |
| Thermal Conditions ⁴ | <ul style="list-style-type: none"> ▶ Operating temperature: 0°C ... +70°C ▶ Storage temperature: -40°C ... +85°C, max. gradient 5°C/min |
| Environmental Conditions ⁴ | <ul style="list-style-type: none"> ▶ Humidity 5% ... 95% RH non condensing ▶ Altitude -300m ... +3000m ▶ Shock 15g 0.33ms, 6g 6ms ▶ Vibration 1g 5-2000Hz |
| EC Regulations | <ul style="list-style-type: none"> ▶ EN55022, EN55024, EN60950-1 (UL60950-1/IEC60950-1) ▶ 2002/95/EC (RoHS) |
| MTBF | tbd |

¹ Not all of these connectors may be present or functional on your actual C23-SATA board. Assembly of these connectors is highly custom specific. Discuss your needs with EKF before ordering.

² Requires CPU carrier board with AC'97 audio support. Contact EKF for an Azalia HD Audio compliant variant of the C23-SATA. The audio facility is provided in the ICH component (AKA southbridge), located on the CPU carrier board. Latest ICH versions no longer support AC'97.

³ Silicon/function may not be present on your actual C23-SATA board. Assembly of components is highly custom specific. Discuss your needs with EKF before ordering.

⁴ Hard disk option may require decrease

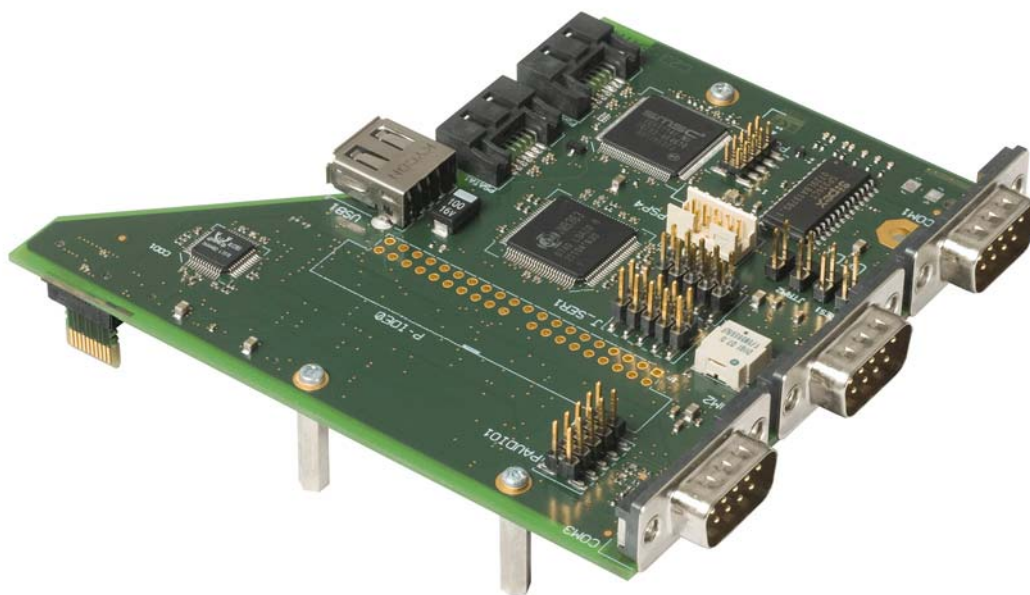

Short Description

Available as a mezzanine add-on expansion board to the CCD-CALYPSO, CCG-RUMBA and successor CPU cards, the C23-SATA provides a number of additional I/O functions. First of all, the C23-SATA comprises an SATA/PATA controller, which is useful for system internal attachment of mass-storage devices (e.g. hard disks or SATA SSD, and optical drives).

Furthermore the C23-SATA is equipped with an SIO, which provides legacy I/O ports, such as serial COM ports, and PS/2 KB/MS. A secondary Firmware Hub can be configured as alternate- or backup-BIOS. Another option available is the Trusted Platform Module according to TPM 1.2 for safety critical applications.

The C23-SATA will be attached on top of the CPU carrier board, and typically shares its front panel with the host carrier (usually 8HP front panel width in total). Interconnection between the C23-SATA I/O module and the CPU carrier board is achieved by two expansion connectors, which comprise the PCIe (PCI Express x 1) and LPC (Low Pin Count) interfaces.

As an option, the C23-SATA can accommodate a low profile industrial grade USB Flash disk module (Silicon State Drive).

The on-board Audio Codec might be useful for applications such as passenger information systems.



C23-SATA on a CPU Carrier Board (8HP Assembly)

The C23-SATA communicates by means of two bottom mount expansion connectors with the host CPU: P-PCIE (PCI Express x 1), and P-EXP (multi-function I/F such as LPC, USB, SMB, AC'97).

The PCI Express interface (connector P-PCIE) requires a single lane (one of up to 4 PCIe lanes provided by the CPU carrier board), which is derived from the ICH (southbridge chip) on the CPU carrier board. The PCIe lane is dedicated to the SATA controller, which is the main component of the C23-SATA.

Connector P-EXP combines several other southbridge data channels: The LPC (Low Pin Count) is a multiplexed ISA bus, e.g. enabling the super-I/O (SIO) controller chip to emulate the legacy I/O interfaces; among these are the classic serial (COM) ports, AKA RS-232 / RS-485.

In addition, two USB channels are provided on the P-EXP connector, in use for the optional on-board USB SSD mezzanine module, and a type A USB receptacle.

If audio support is required on the C23-SATA, either an AC'97 audio codec (CCD-CALYPSO), or HD Audio codec (CCG-RUMBA, CCM-BOOGIE) can be stuffed, dependent from the particular CPU carrier board in use.

The Trusted Platform Module is an optionally available cryptographic chip, which provides a comprehensive hardware and software solution for safer computing. Conforming to the TPM1.2 standard of the TCG, the TPM is comprised of a 16-bit security controller and additional hardware e.g. to generate 2048 bit RSA keys and true random numbers, thus meeting the highest industry rating for digital security.

The C23-SATA fits on the top side of the CPU board, which is on the right side when viewing the common front panel. A suitable backplane provides its CPCI slots beginning with the CPU carrier board (CPCI system slot) from right to left. The CPCI enclosure must provide sufficient mounting space to the right side for the C23-SATA.



Front Panel

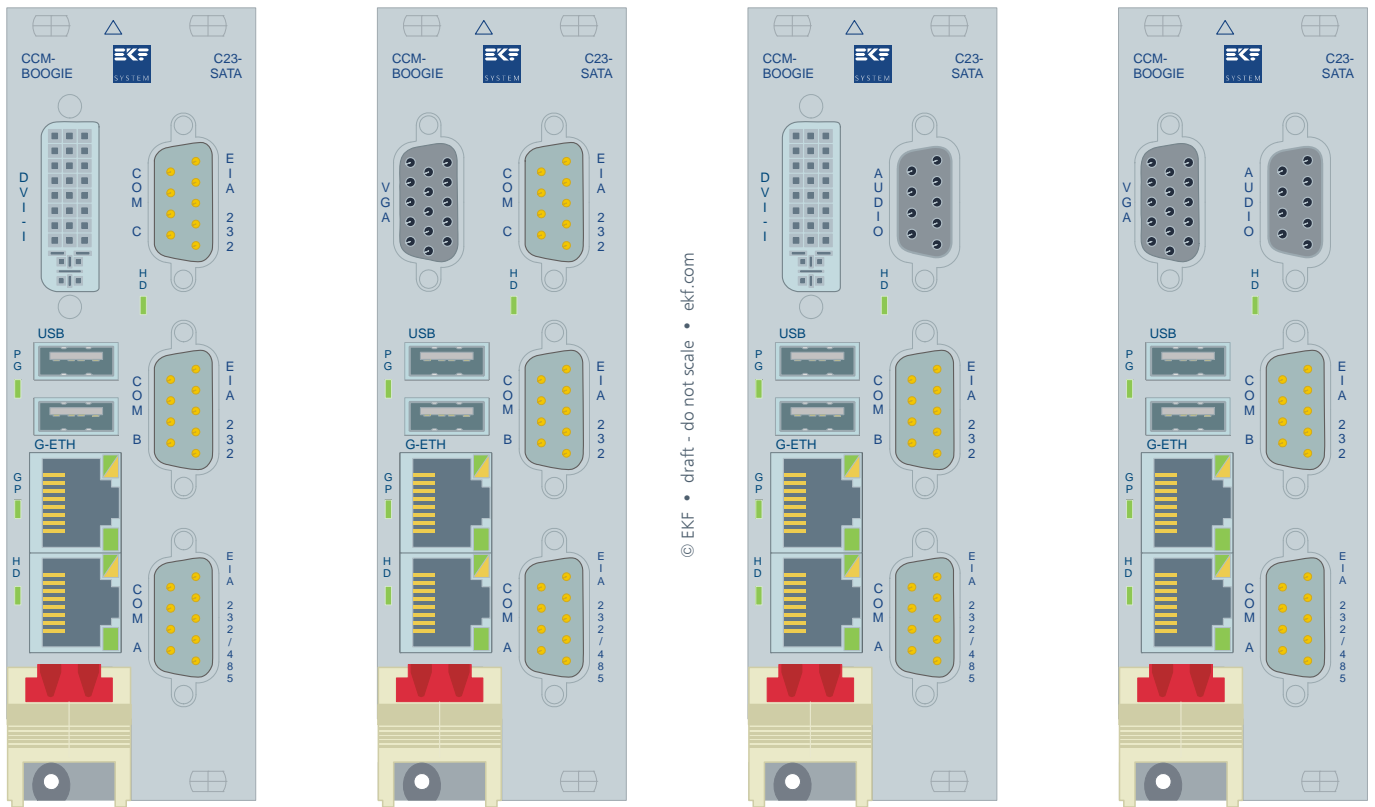

© EKF • Front Panel CCM-BOOGIE DVI/VGA with C23-SATA COM-C/AUDIO Mezzanine Side Board • ekf.com

Typically the carrier board CPU and the C23-SATA share a common 3U/8HP front panel. There may be reasons for further widening of the front panel (e.g. 12HP width); this would provide additional space e.g. for another serial port connector (CU-series module). Please discuss your needs for an individual solution with EKF.

Block Diagram C23-SATA

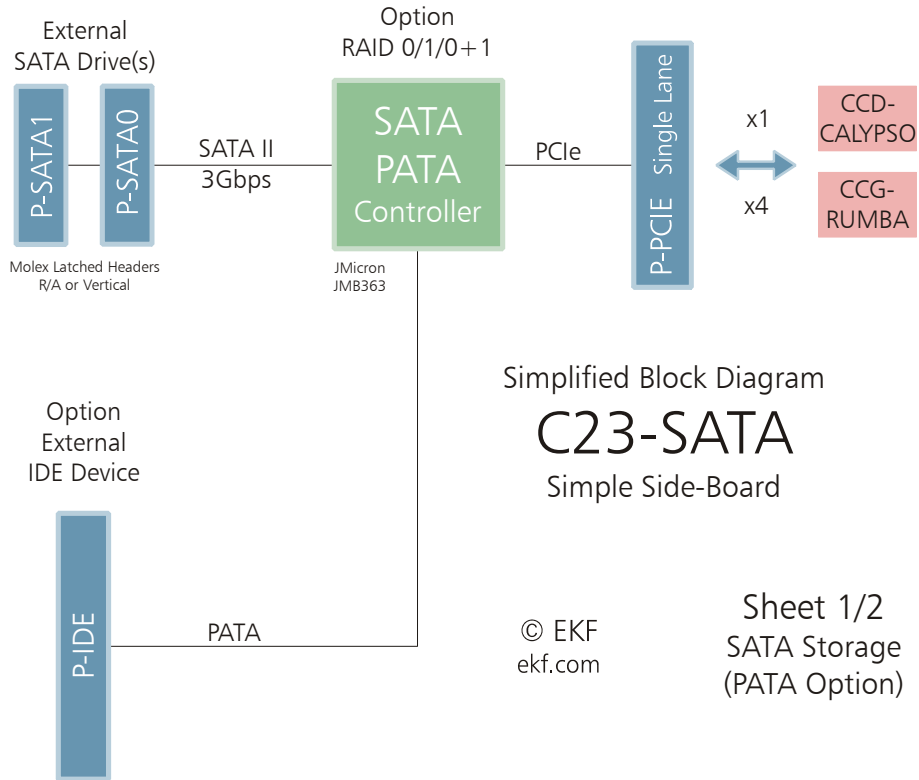

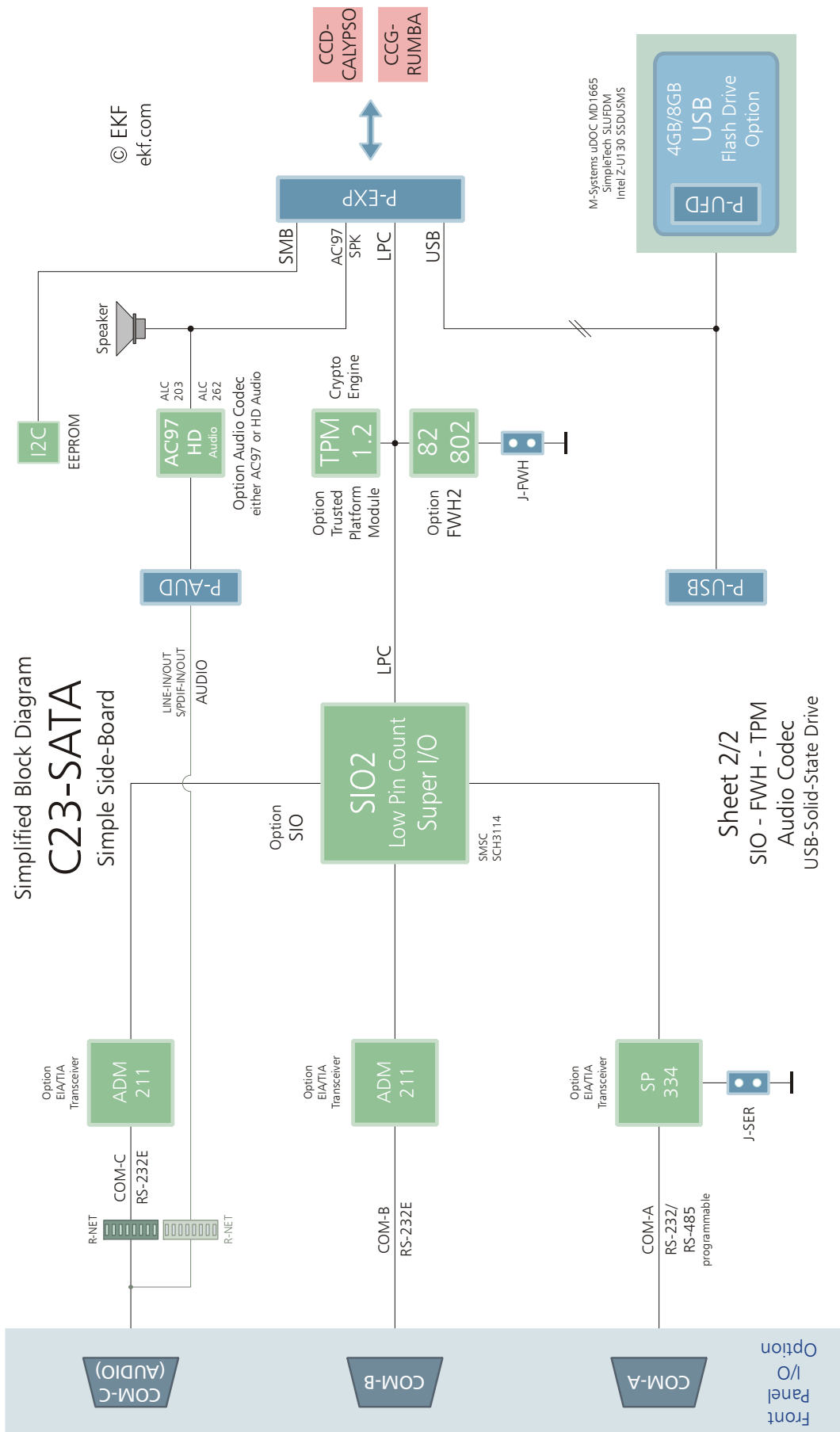

Top View Component Assembly C23-SATA

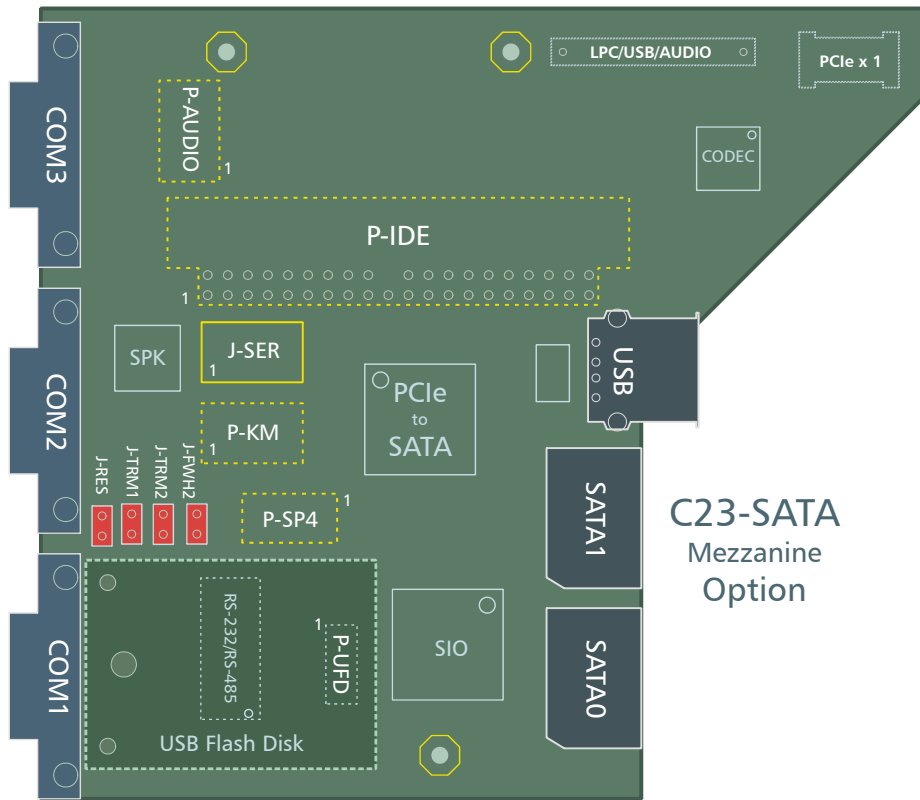

C23-SATA Mezzanine Option

draft only - do not scale • © EKF • ekf.com

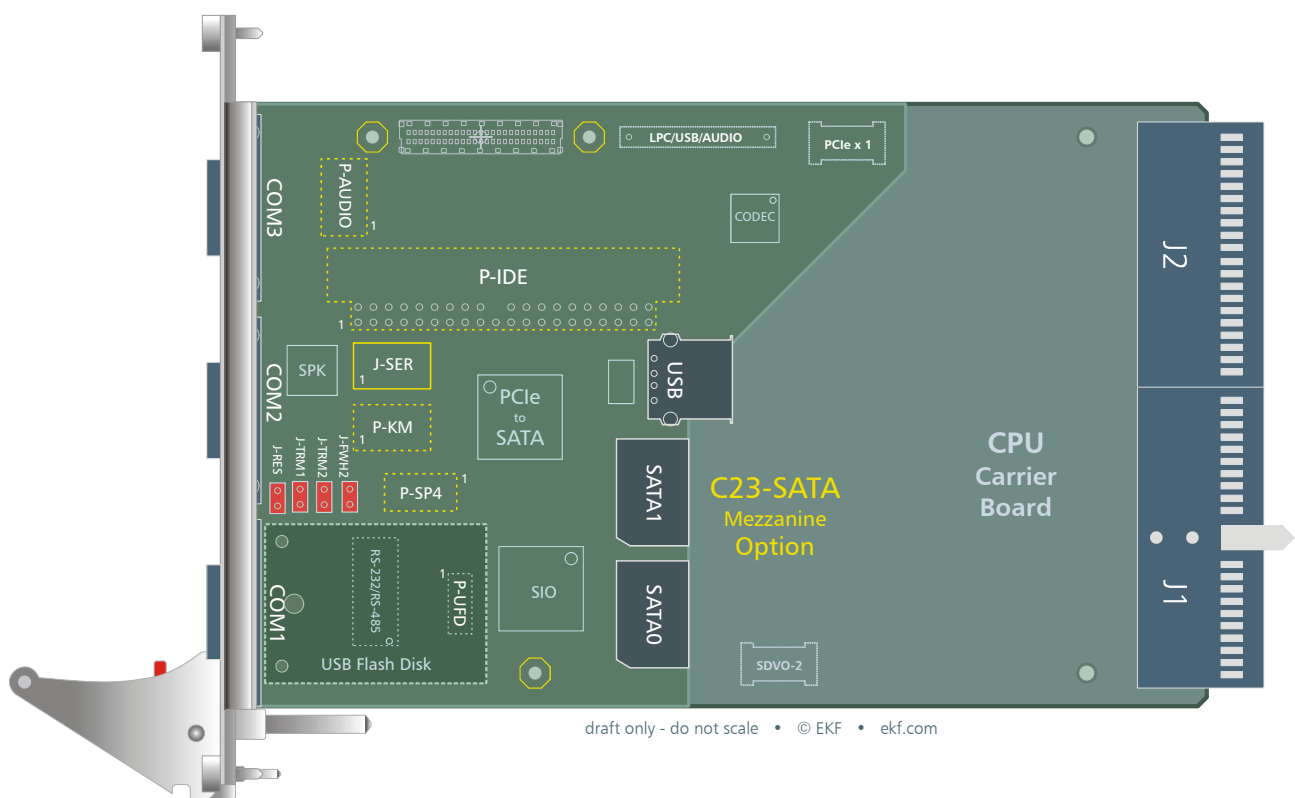

C23-SATA Mezzanine Option

draft only - do not scale • © EKF • ekf.com

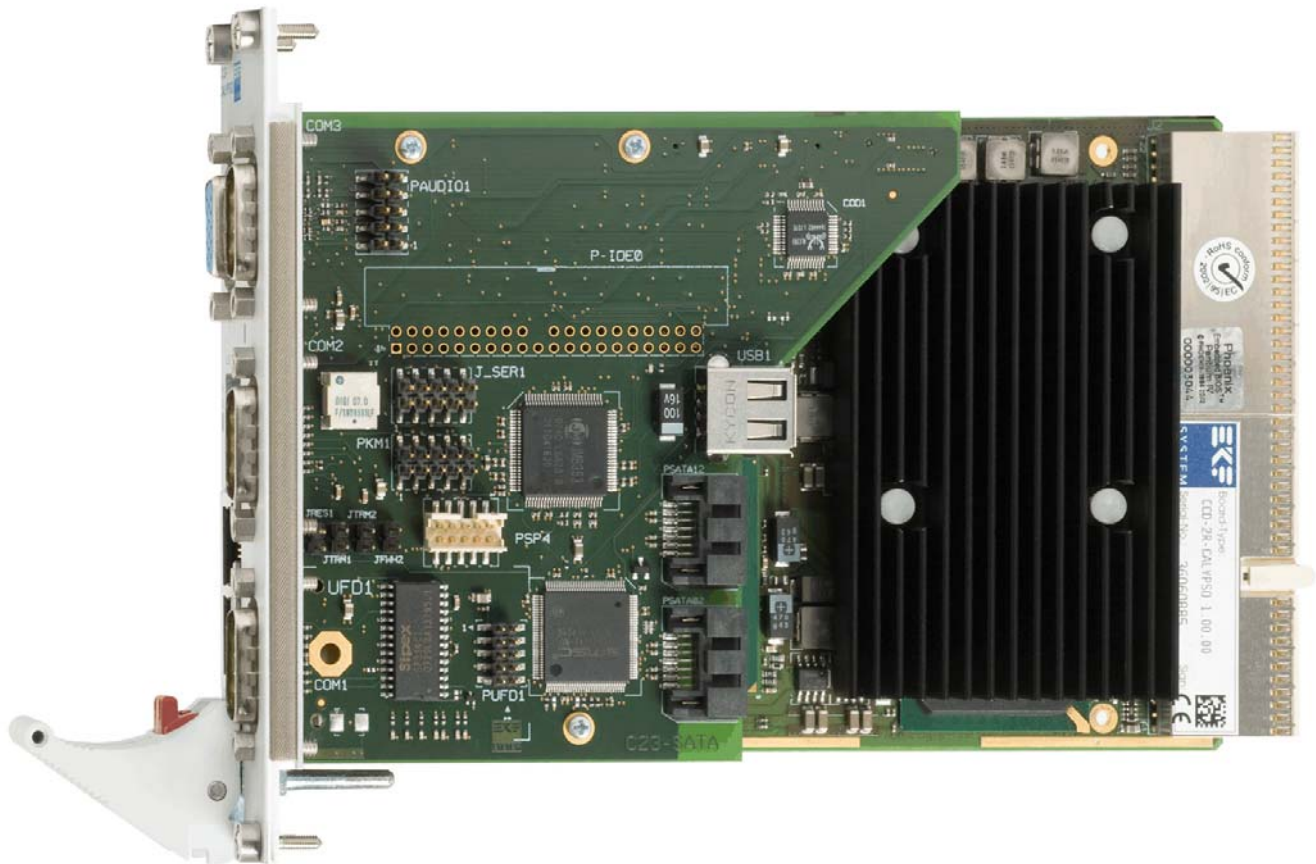

Front Panel Connectors

| | |
|--------------------|---------------------------------------|
| COM-A ¹ | Male D-Sub, RS-232 or RS-485 |
| COM-B ¹ | Male D-Sub, RS-232 |
| COM-C ¹ | Male D-Sub, RS-232 |
| AUDIO | Female D-Sub, replaces COM-C (option) |

On-Board Connectors

| | |
|--------------------|---|
| P-AUDIO | Pin header assigned to the AC'97 audio Codec |
| P-IDE | PATA/IDE connector 2x20 2.54mm pitch horizontal or vertical orientation |
| P-KM | Pin header with PS/2 keyboard and mouse I/O signals (derived from SIO) |
| P-SATA0 P-SATA1 | Horizontal latched SATA headers, 7-position |
| P-SP4 ¹ | Pin header 10-lead 2.00mm, provides TTL level serial COM port signals (suitable for EKF CU-series PHY module) |
| P-UFD | pin header 10-lead 2.00mm pitch, for low profile USB SSD (Solid State Drive) |
| P-USB | A-Type USB receptacle |

¹ Due to a primary SIO which may be present on the CPU board itself, the BIOS may assign COM port numbers different from COM1 to COM4 to these interface lines on the C23-SATA, e.g. COM2 to COM5

Please note:

Not all of the connectors or other elements listed above may be present or functional on your actual C23-SATA board. Assembly of these connectors is highly custom specific. Discuss your needs (target application) with EKF before ordering, for an optimum board configuration.

Jumpers

| | |
|--------------------|--|
| J-FWH ¹ | Jumper 2.54mm, determines if the optional on-board firmware hub is acting as boot BIOS (jumper set) or as secondary BIOS (jumper removed = default). |
| J-RES ¹ | Jumper 2.54mm, allows to force a CPU debug reset on the CCG-RUMBA CPU carrier board |
| J-SER | Jumper array, determines behaviour of COM-A (RS-232 or RS-485) |

¹ Not all of these jumpers may be present or functional on your actual C23-SATA board. Assembly of these jumpers is highly custom specific. Discuss your needs with EKF before ordering.

Inter-Board Connectors

| | |
|--------|---|
| P-EXP | Dual row socket, available from bottom of the C23-SATA PCB, matching with the corresponding socket on the CPU carrier board, connected through a board stacker, comprising of: <ul style="list-style-type: none"> • LPC Low Pin Count interface • AC'97 Audio or HD Audio • 2 x USB • SMB, Speaker, Reset |
| P-PCIE | High speed socket edge card connector, available from bottom of the C23-SATA PCB, matching with the corresponding socket on the CPU carrier board, connected through a high speed strip line PCB (EKF C21 or C26, depends on CPU carrier board), comprising of: <ul style="list-style-type: none"> • Host CPU (ICH southbridge) PCI Express (PCIe) x 1 interface |

Please note:

Not all of the connectors or other elements listed above may be present or functional on your actual C23-SATA board. Assembly of these connectors is highly custom specific. Discuss your needs (target application) with EKF before ordering, for an optimum board configuration.

Installing and Replacing Components

Before You Begin

Warnings

The procedures in this chapter assume familiarity with the general terminology associated with industrial electronics and with safety practices and regulatory compliance required for using and modifying electronic equipment. Disconnect any telecommunication links, networks or procedures described in this chapter. Failure links before you open the system or perform or equipment damage. Some parts of the the power switch is in its off state.



the system from its power source and from modems before performing any of the to disconnect power, or telecommunication any procedures can result in personal injury system can continue to operate even though

Caution

Electrostatic discharge (ESD) can damage components. Perform the procedures described in this chapter only at an ESD workstation. If such a some ESD protection by wearing an metal part of the system chassis or board original ESD protected packaging. Retain the antistatic box) in case of returning the board to EKF for repair.



station is not available, you can provide antistatic wrist strap and attaching it to a front panel. Store the board only in its original packaging (antistatic bag and

Installing the Board

Warning

This procedure should be done only by qualified technical personnel. Disconnect the system from its power source before doing the procedures described here. Failure to disconnect power, or telecommunication links before you open the system or perform any procedures can result in personal injury or equipment damage.

Typically you will perform the following steps:

- Switch off the system, remove the AC power cord
- Attach your antistatic wrist strap to a metallic part of the system
- Remove the board assembly packaging, be sure to touch the board only at the front panel
- Identify the related CompactPCI slot (peripheral slot for I/O boards, system slot for CPU boards, with the system slot typically most right or most left to the backplane)
- Insert card carefully (be sure not to damage components mounted on the bottom side of the board by scratching neighbored front panels)
- A card with onboard connectors requires attachment of associated cabling now
- Lock the ejector lever, fix screws at the front panel (top/bottom)
- Retain original packaging in case of return



Removing the Board

Warning

This procedure should be done only by qualified technical personnel. Disconnect the system from its power source before doing the procedures described here. Failure to disconnect power, or telecommunication links before you open the system or perform any procedures can result in personal injury or equipment damage.

Typically you will perform the following steps:

- Switch off the system, remove the AC power cord
- Attach your antistatic wrist strap to a metallic part of the system
- Identify the board, be sure to touch the board only at the front panel
- unfasten both front panel screws (top/bottom), unlock the ejector lever
- Carefully remove any board to system cabling assembly
- Activate the ejector lever
- Remove the card assembly carefully (be sure not to damage components mounted on the bottom side of the board by scratching neighbored front panels)
- Store board assembly in the original packaging, do not touch any components, hold the board at the front panel only



Warning

Do not expose the card to fire. Battery cells and other components could explode and cause personal injury.





EMC Recommendations

In order to comply with the CE regulations for EMC, it is mandatory to observe the following rules:

- The chassis or rack including other boards in use must comply entirely with CE
- Close all board slots not in use with a blind front panel
- Front panels must be fastened by built-in screws
- Cover any unused front panel mounted connector with a shielding cap
- External communications cable assemblies must be shielded (shield connected only at one end of the cable)
- Use ferrite beads for cabling wherever appropriate
- Some connectors may require additional isolating parts

Reccomended Accessories

| | | |
|-------------------------|--------------------------------------|--|
| Blind CPCI Front Panels | EKF Elektronik | Widths currently available (1HP=5.08mm): with handle 4HP/8HP without handle 2HP/4HP/8HP/10HP/12HP |
| Ferrit Bead Filters | ARP Datacom, 63115 Dietzenbach | Ordering No. 102 820 (cable diameter 6.5mm) 102 821 (cable diameter 10.0mm) 102 822 (cable diameter 13.0mm) |
| Metal Shielding Caps | Conec-Polytronic, 59557 Lippstadt | Ordering No. CDFA 09 165 X 13129 X (DB9) CDSFA 15 165 X 12979 X (DB15) CDSFA 25 165 X 12989 X (DB25) |

Technical Reference - Connectors

Caution

Some of the connectors may provide operating voltage (e.g. +12V, +5V and +3.3V) to devices inside the system chassis, such as internal peripherals. Not all of these connectors are overcurrent protected. Do not use these connectors for powering devices external to the computer chassis. A fault in the load presented by the external devices could cause damage to the board, the interconnecting cable and the external devices themselves.

Please Note

The C23-SATA mezzanine module may be equipped with several on-board connectors for system internal usage. Not all of these connectors may be present on a particular board. Be sure to specify your individual needs when ordering the C23-SATA board. Characteristic features and the pin assignments of each connector are described on the following pages (connector designation in alphabetical order within the groups 'front panel connectors', 'on-board connectors', 'inter-board connectors', and 'rear I/O connectors').

Front Panel Connectors

As of current, suitable CPU carrier boards for use together with the C23-SATA mezzanine module are the CCD-CALYPSO, CCG-RUMBA and the CCM-BOOGIE. The C23-SATA side board mounts on top (at the right side) of the carrier card. By default, the C23-SATA shares an 8HP (~40.6mm) front panel with the CPU carrier board. Furthermore, custom specific front panel options are available on request. Shown below is the basic variant of the C23-SATA with three COM port connectors (illustration with CCM-BOOGIE front panel). As an option, COM-C may be replaced by a female D-Sub 9 for audio I/O.

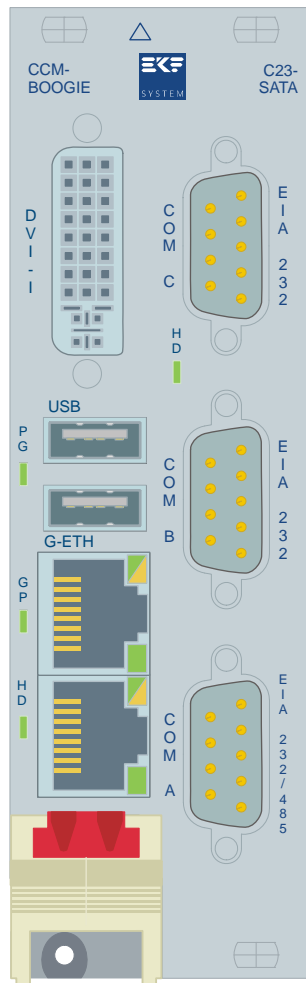

C23-SATA

COM-A (RS-232/RS-485)

| Front Panel Male D-SUB9 Connector EKF Part No. 261.02.009.23 | | | |
|--|---|---|----------------|
| RS-232 | | | |
| | | 1 | DCD (Input) |
| DSR (Input) | 6 | | |
| | | 2 | RxD (Input) |
| RTS (Output) | 7 | | |
| | | 3 | TxD (Output) |
| CTS (Input) | 8 | | |
| | | 4 | DTR (Output) |
| RI (Input) | 9 | | |
| | | 5 | GND |
| RS-485 | | | |
| | | 1 | DSR- (Input) |
| DSR+ (Input) | 6 | | |
| | | 2 | RxD- (Input) |
| TxD- (Output) | 7 | | |
| | | 3 | TxD+ (Output) |
| RxD+ (Input) | 8 | | |
| | | 4 | do not connect |
| do not connect | 9 | | |
| | | 5 | GND |

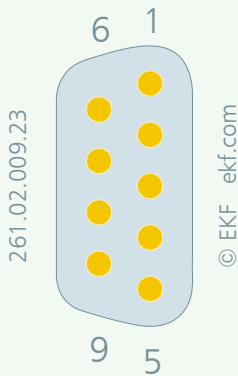

The C23-SATA is equipped with three serial transceivers. This is a short description of TR1 (COM port A), which corresponds to the lower front panel D-Sub 9 connector. The transceiver is a Sipex/EXAR SP334 and can be operated in either TIA/EIA-232 mode (AKA RS-232), or in TIA/EIA-485 mode (AKA RS-485). According to the transfer mode selected, the pin designations of the D-Sub connector will change. Attachment of a RS-232 peripheral to the COM-A connector while having selected the RS-485 operating mode should be avoided, just as vice versa.

For selection of the TR1 operating mode, a five position dual row pin header is provided, named J-SER. A single jumper selects between the following transfer characteristics:

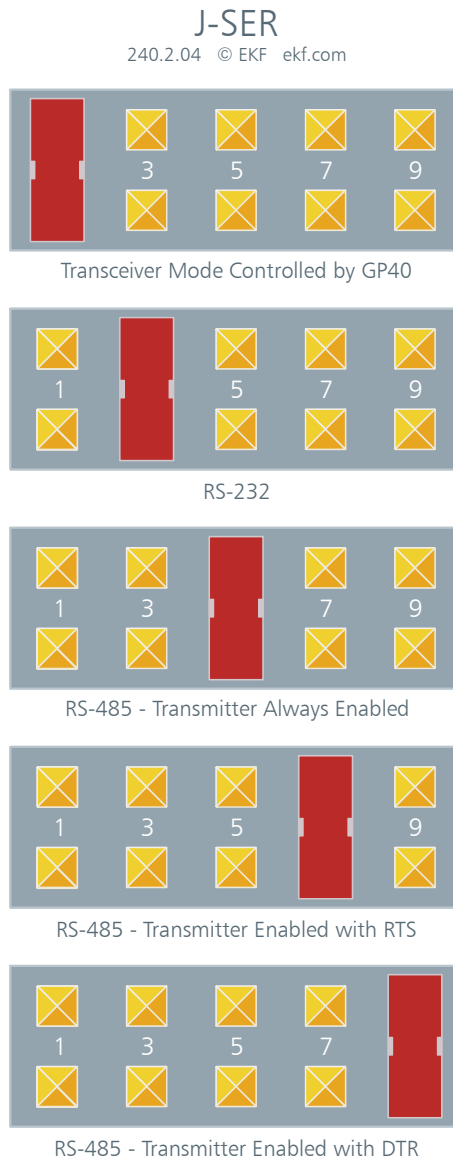

- Jumper J-SER position 3 must be set for RS-232 operation. Remove also jumpers J-TRM1 and J-TRM2.
- Jumper position 5 is suitable for RS-485 point-to-point connection (full-duplex mode = sending and receiving data simultaneously across a double twisted pair cable). The TxD transmitter is permanently enabled.
- Jumper positions 7 and 9 must correspond to the software protocol in use in a bus structured RS-485 topology (party line, transmitter outputs and receiver inputs connected together using a single twisted pair cable, half-duplex transmission). Either RTS or DTR can be used for transmitter control.

In rare cases, a node has to be configured as listener only. Simply remove the jumper from J-SER in order to permanently disable the RS-485 TxD transmitter.

Please note: Do not stuff more than a single jumper to J-SER. Do not install the jumper to other positions than shown above.

In addition to J-SER, there may be two jumpers provided for on-board line termination of the RS-485

transmit- and receive signals:

- ▶ If set, J-TRM1 terminates the transmitter signal pair (output)
- ▶ If set, J-TRM2 terminates the receiver signal pair (input)

Typically, the termination resistors are chosen as 120 Ohm each (some people prefer 100 Ohms). For half duplex mode (receive and transmit connected to each other) set either J-TRM1 or J-TRM2, but not both.

A data transmission line operated in RS-485 mode must be terminated at both endings of the twisted pair transmission cable (bus topology obligatory). Please avoid multiple termination for party-line systems. Also **be aware to avoid double termination**, both on-board and simultaneously in the external connector attached to COM-A.

COM-B COM-C (RS-232)

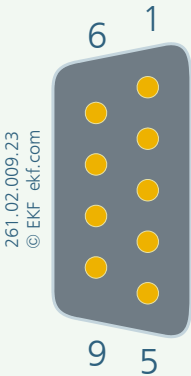
| COM-B/C RS-232 Male D-Sub 9 261.02.009.23 | | | | |
|--|----------|---|---|----------|
|  | | | 1 | DCD2 (3) |
| | DSR2 (3) | 6 | | |
| | | | 2 | RXD2 (3) |
| | RTS2 (3) | 7 | | |
| | | | 3 | TXD2 (3) |
| | CTS2 (3) | 8 | | |
| | | | 4 | DTR2 (3) |
| | RI2 (3) | 9 | | |
| | | | 5 | GND |

The C23-SATA is equipped with two ADM211 serial transceivers, assigned to COM-B and COM-C. As an option however, the front panel position for COM-C may be occupied by the audio connector.

Audio Connector

As an option, the front panel position COM-C may be used for audio I/O instead. In order to avoid confusion, the audio connector is a female D-Sub (while COM ports are equipped with male D-Sub connectors).

| Front Panel Audio Option RS-232 Female D-Sub 9 261.01.009.23 | | | | |
|---|----------------|---|---------------|----------------|
|  | | 5 | LINE IN R (C) | |
| | LINE IN L (C) | 9 | | |
| | | | 4 | A-GND |
| | LINE OUT R (D) | 8 | | |
| | | | 3 | LINE OUT L (D) |
| | A-GND | 7 | | |
| | | | 2 | S/PDIF OUT |
| | S/PDIF IN | 6 | | |
| | | | 1 | D-GND |

The C23-SATA can be equipped with either an AC'97 audio codec (Realtek ALC203) for analog and digital audio support, or HD Audio codec (ALC262) at the users choice, matching the particular CPU carrier board in use. Both AC'97 or HD Audio data stream is derived from the ICH (southbridge) on the CPU carrier board. AC'97 is available with the CCD-CALYPSO, and HD Audio (aka Azalia) is supported with the CCG-RUMBA and the CCM-BOOGIE.

For download of the latest audio drivers, please refer to the Realtek website (www.realtek.com.tw).

On-Board Connectors

The C23-SATA can be equipped with several on-board connectors. Some of these connectors are available as an option only or exclusive to each other, and therefore may not be functional or even present on your actual board.

Assembly of these connectors is highly custom specific. Discuss your needs with EKF before ordering, so that the optimum board configuration for your application will be chosen.

P-AUDIO

As an option, the C23-SATA can be equipped with a pin header for system internal audio I/O. P-AUDIO corresponds to the optional on-board AC'97 Audio Codec.

P-AUDIO SMT 2.54mm Pin Header 2 x 5 (241.1.0205.20.00)

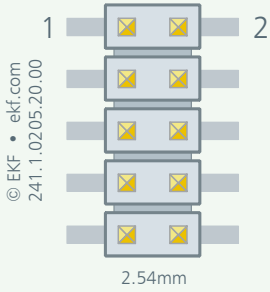
| | | | | |
|---|-------------|---|----|---------------|
|  | Digital GND | 1 | 2 | S/PDIF In |
| | S/PDIF Out | 3 | 4 | Analog GND |
| | Line Out L | 5 | 6 | Line Out R |
| | Analog GND | 7 | 8 | Line In L |
| | Line In R | 9 | 10 | not connected |

If the optional front panel audio connector is stuffed, the internal header P-AUDIO is not available, in order to avoid signal interference.

P-IDE

The C23-SATA is optionally provided with a PATA/IDE header, suitable for system internal attachment of up to 2 mass storage devices via flat cable harness, configured as IDE master and slave. The P-IDE is a right angle type for maintaining the 4HP envelope of the C23-SATA (vertical header on request).

| P-IDE3 IDE Device Header R/A 2.54mm 2 x 20 (260.02.040.19) | | | | |
|--|-------------|----|----|-------------|
| | IDE_RESET# | 1 | 2 | GND |
| | IDE1_DD07 | 3 | 4 | IDE1_DD08 |
| | IDE1_DD06 | 5 | 6 | IDE1_DD09 |
| | IDE1_DD05 | 7 | 8 | IDE1_DD10 |
| | IDE1_DD04 | 9 | 10 | IDE1_DD11 |
| | IDE1_DD03 | 11 | 12 | IDE1_DD12 |
| | IDE1_DD02 | 13 | 14 | IDE1_DD13 |
| | IDE1_DD01 | 15 | 16 | IDE1_DD14 |
| | IDE1_DD00 | 17 | 18 | IDE1_DD15 |
| | GND | 19 | 20 | KEY |
| | IDE1_DMARQ | 21 | 22 | GND |
| | IDE1_DIOW# | 23 | 24 | GND |
| | IDE1_DIOR# | 25 | 26 | GND |
| | IDE1_IORDY | 27 | 28 | GND |
| | IDE1_DMACK# | 29 | 30 | GND |
| | IDE1_INTRQ | 31 | 32 | NC |
| | IDE1_DA1 | 33 | 34 | IDE1_CBLID# |
| | IDE1_DA0 | 35 | 36 | IDE1_DA2 |
| | IDE1_CS0# | 37 | 38 | IDE1_CS1# |
| | IDE0_ACT# | 39 | 40 | GND |

P-KM

As an option, the C23-SATA is available with a pin header that provides the legacy PS/2 keyboard and mouse signals, derived from the on-board SIO component. A suitable cable harness or small PCB would be needed in addition, for translation to the PS/2 style DIN round connector(s).

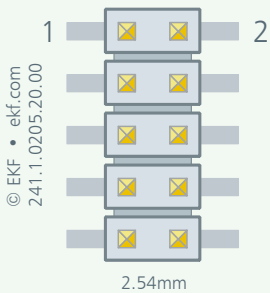
| P-KM Keyboard - Mouse PS/2 Signals SMT 2.54mm Pin Header 2 x 5 (241.1.0205.20.00) | | | | |
|---|---------------------------|---|----|----------------|
|  | +5V Mouse ¹ | 1 | 2 | Clock Mouse |
| | GND Mouse | 3 | 4 | Data Mouse |
| | NC | 5 | 6 | NC |
| | +5V Keyboard ¹ | 7 | 8 | Clock Keyboard |
| | GND Keyboard | 9 | 10 | Data Keyboard |

¹ short circuit protection by a common PolySwitch self resettable fuse, voltage derived from +5V_CR carrier board switched power well

P-SATA0 P-SATA1

The C23-SATA will be typically stuffed with two latched SATA signal headers, either right angle style, or vertical mount, for attachment of system internal SATA drives by cable. TX/RX designation of signals is with respect to the SATA controller. P-SATA0 corresponds to the SATA channel 0 of the JMB363 controller, and P-SATA1 is wired to the JMB363 SATA channel 1.

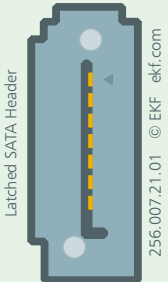
| P-SATA0 P-SATA1 #256.007.21.01 Latched Headers | | |
|---|---|----------|
|  | 1 | GND |
| | 2 | SATA_TX+ |
| | 3 | SATA_TX- |
| | 4 | GND |
| | 5 | SATA_RX- |
| | 6 | SATA_RX+ |
| | 7 | GND |

The SATA channels may be used individually, or aggregated as RAID 0/1/10. It is also possible to include the PATA devices into the RAID management. The latest driver can be downloaded from the JMicron website (<ftp://driver.jmicron.com.tw/jmb36x/>).

P-SP4

The on-board SIO (Super I/O controller) provides up to four serial interfaces (UART, DOS COM ports). While three serial ports are assigned to RS-232 transceivers for front panel I/O, another UART is available in addition from the optional pin header P-SP4 (TTL-level on all signals). P-SP4 is suitable for attachment of an EKF CU-series PHY module via a micro ribbon flat cable assembly. A PHY module is a transceiver from TTL level signals to a specific symmetric or asymmetric interface standard, e.g. EIA-485 or RS-232E, with or w/o galvanic isolation. Please contact sales@ekf.de for availability of different CU-series modules (inquiries for custom specific PHY or transition modules welcome). Also custom specific front panel design can be done.

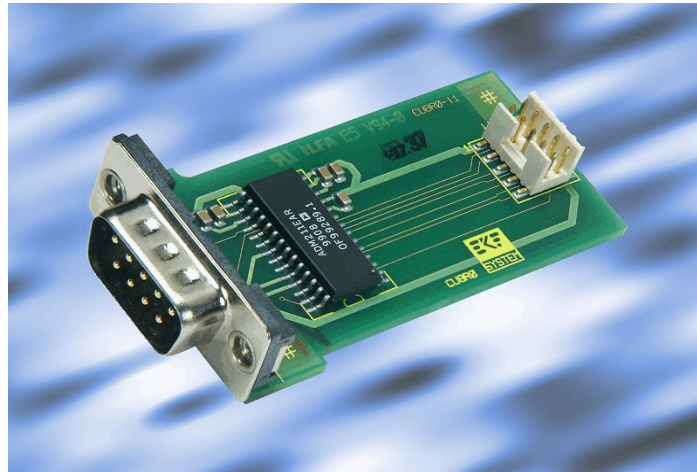

CU-Series PHY Module

Due to another (primary) SIO typically available on the CCG-RUMBA host board, the serial interfaces are not necessarily assigned to COM-1/COM-4 by the operating system. Verify or modify the accompanying CCG-RUMBA (or other CPU carrier board) BIOS settings for mapping of physical asynchronous serial I/O ports to the logical COM port order.

Alternatively the connector P-SP4 can be used as 5V tolerant programmable I/O (GPIO). Details can be derived from the SCH3114 Super I/O controller data sheet (www.smsc.com).

A special signal pair may be used as GPO for alternate purposes (not in use by default):

- ▶ SP4_DTR# can be configured (stuffing option) as SMBus EEPROM address line A1
- ▶ SP4_RTS# can be configured as SMBus EEPROM Write Protect WP

P-SP4 TTL-Level Serial I/O or GPIO 2.00mm Pin Header 2 x 5 (277.01.010.21)

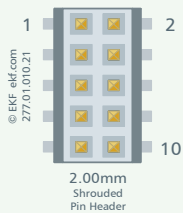

| | | | |
|---------------------------|---|----|---------------------------|
| +5V_SP4 0.5A ¹ | 1 | 2 | DSR4# / GP66 |
| RI4# / GP31 | 3 | 4 | RXD4 / GP64 |
| TXD4 / GP65 | 5 | 6 | DTR4# / GP34 ² |
| RTS4# / GP67 ² | 7 | 8 | CTS4# / GP62 |
| DCD4# / GP63 | 9 | 10 | GND |

¹ short circuit protection by a PolySwitch resettable fuse, voltage derived from +5V_CR carrier board switched power well

² as a stuffing option (zero ohms resistors), GP34 may be also in use to control the on-board SMBus identification EEPROM address line input A1, and GP67 may be in use to control the on-board SMBus identification EEPROM write protection input WP, hence interference with concurrent running serial port driver software must be avoided

P-UFD

As an option, the C23-SATA can be equipped with a pin header for an industrial style USB Flash disk mezzanine module. The connector is a 2.0mm pitch pin header, suitable for a low profile SSD (Solid-State Drive) 37mm x 26mm. As of current, such modules are available e.g. from STEC, Intel, SanDisk and other manufacturers, up to 8GByte.

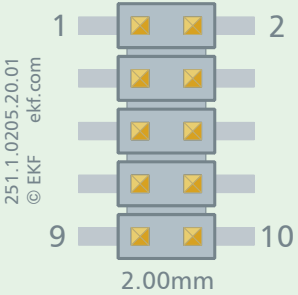
| P-UFD • 2.00mm Pin Header 2x5 (251.1.0205.20.01) | | | | |
|---|-----------|---|----|----|
| USB Solid-State Drive (Low Profile) 562.20.0004.00 (4GB) | | | | |
| Sandisk uSSD 5000 • STec SLUFDM • Intel Z-U130 SSDUSMS | | | | |
|  | +5V_CR | 1 | 2 | NC |
| | USB_D- | 3 | 4 | NC |
| | USB_D+ | 5 | 6 | NC |
| | GND | 7 | 8 | NC |
| | Mech. Key | 9 | 10 | NC |

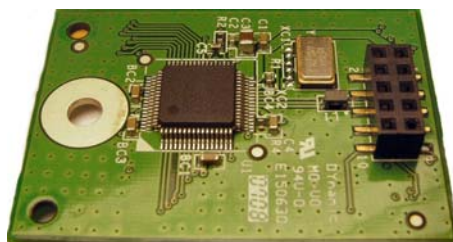

USB SSD

P-UFD is provided as a stuffing option only, for a top mount SSD module. The C23-SATA USB ports are derived from the CPU carrier board ICH (southbridge), available via connector P-EXP.



P-USB

The C23-SATA can be equipped with an USB type A receptacle for attachment of system internal devices. The connector is a R/A style jack in order to maintain the 4HP envelope of the mezzanine card.

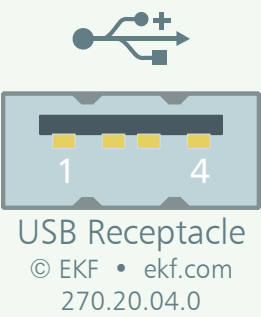
| USB Receptacle USB 270.20.04.0 | | |
|---|---|-----------------|
|  | 1 | +5V_USB 0.5A 1) |
| | 2 | DATA- |
| | 3 | DATA+ |
| | 4 | GND |

¹⁾ protected by electronic switch

The USB channel is derived from the CPU carrier board ICH (southbridge), routed across the P-EXP connector. An electronic switch is provided on the C23-SATA for short-circuit protection.

On-Board Jumpers

Most options on the C23-SATA are stuffing options, so there are only 2 jumpers which are available for user interaction, J-RES (force reset) and J-FWH2 (select Firmware Hub).

J-RES

Provided as an option, the pin header J-RES can be used for resetting the CPU host board (processor reset) if wired to additional circuitry (e.g. watchdog or manual pushbutton). Tie reset# to GND with an open collector output. While debugging the system, a 2.54mm jumper may be used to force a manual reset.



J-FWH2

Selection of BIOS to boot from. Please see description in chapter 'Firmware Hub 2'.

J-SER

COM-A mode select RS-232 - RS-485. Please refer to detailed description in chapter 'COM-A' front panel connector.

J-TRM1 J-TRM2

On-Board line termination transmit/receive RS-485. Please refer to detailed description in chapter 'COM-A' front panel connector.

Inter-Board Connectors

The C23-SATA is equipped with 2 inter-board connectors. These are the P-EXP (LPC and mixed signals), and the P-PCle (1-Lane PCI Express) connectors. All inter-board connectors are situated at the bottom of the C23-SATA and establish the data path and power link to the carrier board CPU. As the C23-SATA comes typically mounted as a unit together with the CCG-RUMBA or another CPU carrier board, there is normally no need for the user to get access to any of the inter-board connectors. They are described here as a reference only and for better understanding of the C23-SATA.

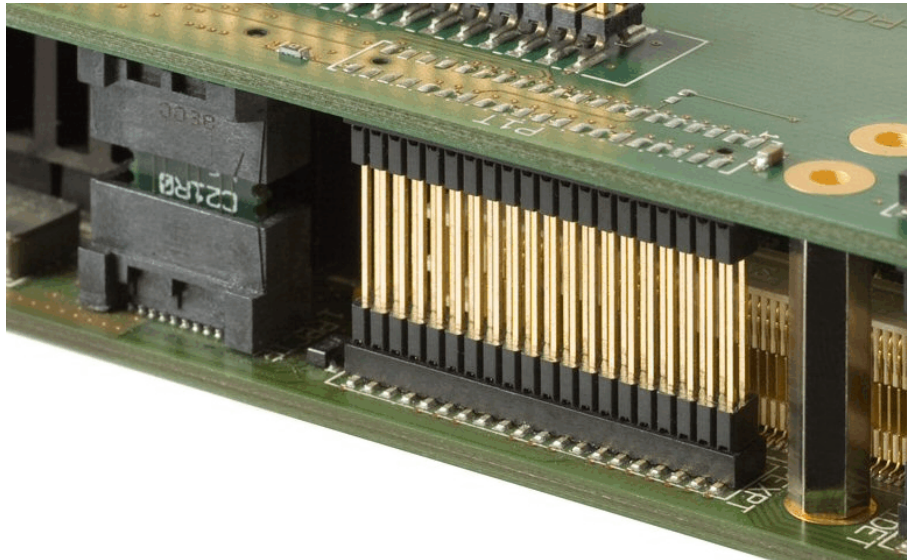

P-PCIE (left) & P-EXP (right)

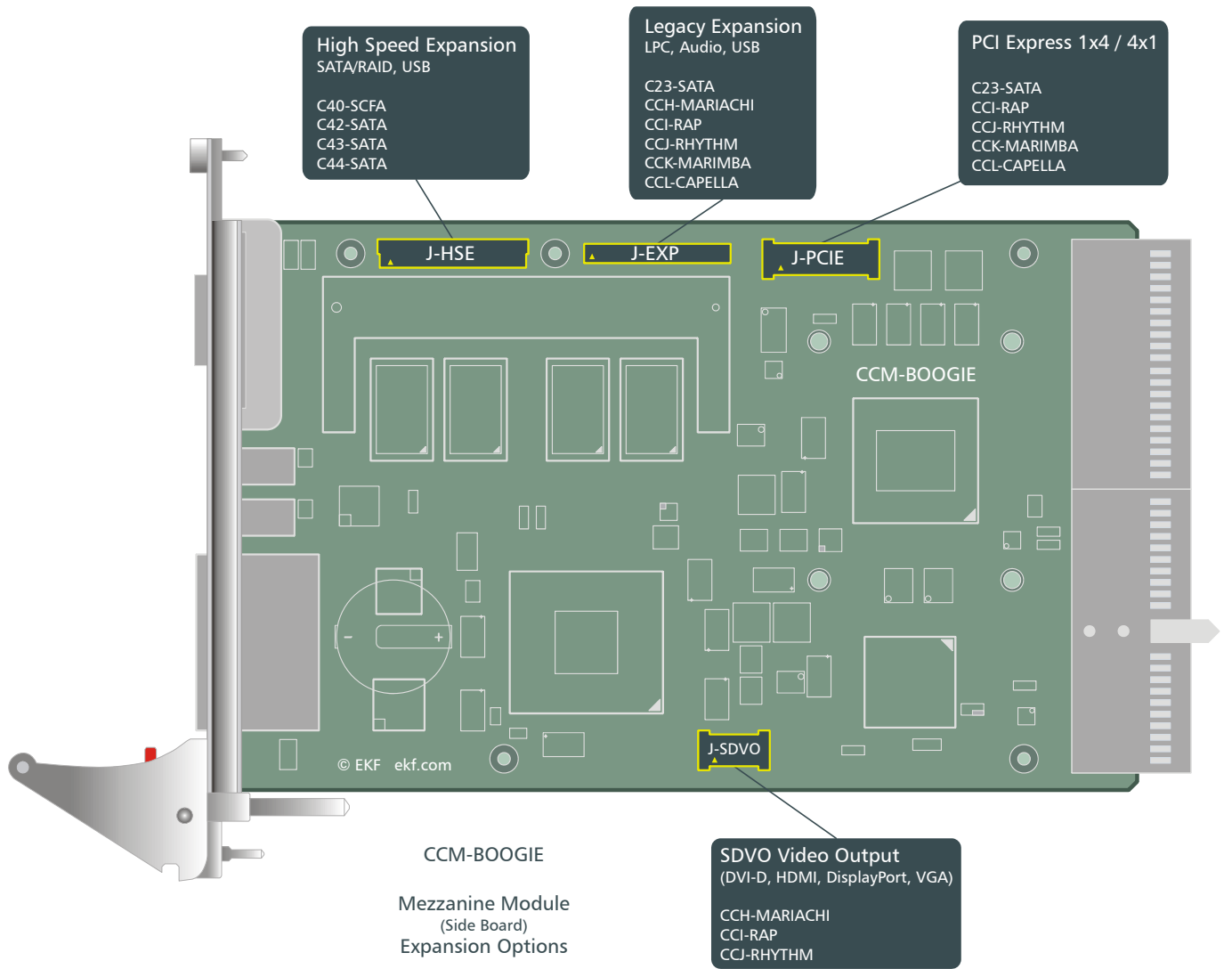

P-EXP

The inter-board connector P-EXP is mounted on bottom of the C23-SATA PCB, with its face aligned towards the corresponding connector on the CCG-RUMBA. This allows to attach the C23-SATA mezzanine companion card on top of the CPU carrier board. A suitable board stacker is used in addition to bridge the gap between the two boards (exactly 4HP distance between PCBs). P-EXP is used to pass the Low Pin Count I/F to the C23-SATA, besides USB channels and other sideband signals.

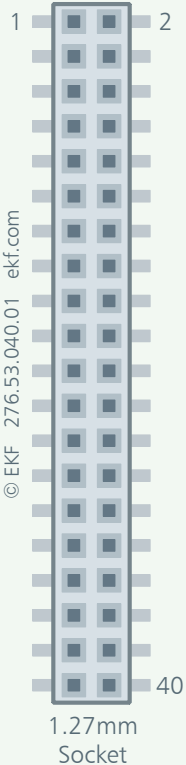
| P-EXP Expansion Board Interface (LPC/HD-Audio/USB) 1.27mm Socket 2 x 20 (276.53.040.01) | | | | |
|--|--|----|----|--|
|  <p>pin orientation shows CPU carrier board top view</p> | GND | 1 | 2 | +3.3V_CR * |
| | CLK_33MHZ | 3 | 4 | PLTRST# |
| | LPC_AD0 | 5 | 6 | LPC_AD1 |
| | LPC_AD2 | 7 | 8 | LPC_AD3 |
| | LPC_FRAME# | 9 | 10 | LPC_DRQ# |
| | GND | 11 | 12 | +3.3V_CR * |
| | SERIRQ | 13 | 14 | PME# |
| | SMI# | 15 | 16 | CLK_14MHZ |
| | FWH_ID0 | 17 | 18 | FWH_INIT# |
| | KBD_RST# | 19 | 20 | A20GATE |
| | GND | 21 | 22 | +5V_CR * |
| | USB_P2N ¹ | 23 | 24 | USB_P1N ² |
| | USB_P2P ¹ | 25 | 26 | USB_P1P ² |
| | USB_OC# ³ | 27 | 28 | DBRESET# |
| | SMB_CLK | 29 | 30 | SMB_DAT |
| | GND | 31 | 32 | +5V_CR * |
| | PE Port Cfg Bit 1 ⁴ AC'97_SDOOUT | 33 | 34 | AC'97_SDIN0 |
| | AC'97_RST# | 35 | 36 | PE Port Cfg Bit 0 ⁴ AC'97_SYNC |
| | AC'97_BITCLK | 37 | 38 | AC'97_SDIN1 |
| | SPEAKER | 39 | 40 | +12V_CR |

¹ connects to USB Port 6 on CCG-RUMBA

² connects to USB Port 5 on CCG-RUMBA

³ connects to USB_OC56# on CCG-RUMBA

⁴ PCI Express port configuration defaults to 4 links by 1 lane (1 link x 1 lane used on the C23-SATA)

* switched power supply lines from CPU carrier board according to Sx state

P-PCIE

The high speed expansion socket P-PCIE is mounted on bottom of the C23-SATA. This allows to attach the mezzanine companion card on top of the CPU carrier board. A mating strip line spacer PCB (C21-PCIEX1 for CCD-CALYPSO, and C26-PCIEX3 with respect to the CCG-RUMBA and CCM-BOOGIE carrier boards) is used in addition to bridge the gap between the two boards, which results from the horizontal 0.8-inch (20.32mm) card slot pitch.

P-PCIE is organized as single link, single lane, and is required for the SATA controller chip only. If the C23-SATA board is solely used for RS-232 serial I/O, P-PCIE may be obsolete.

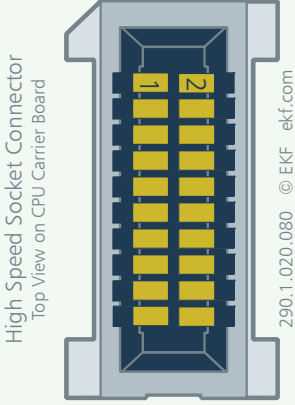
| P-PCIE PCI Express x 1 High Speed Dual Row Socket 0.8mm Pitch 290.1.020.080 | | | | |
|---|---------------------|----|----|-----------------------|
|  <p>High Speed Socket Connector Top View on CPU Carrier Board</p> <p>290.1.020.080 © EKF ekf.com</p> <p>pin orientation shows CPU carrier board top view (see-trough C23-SATA PCB)</p> <p>¹ switched on/off power lines on CPU carrier board according to S3 state</p> | GND | 1 | 2 | GND |
| | +5V_CR ¹ | 3 | 4 | +3.3V_CR ¹ |
| | +5V_CR ¹ | 5 | 6 | +3.3V_CR ¹ |
| | GND | 7 | 8 | GND |
| | PE_CLKP | 9 | 10 | PLTRST# |
| | PE_CLKN | 11 | 12 | PE_WAKE# |
| | GND | 13 | 14 | GND |
| | PEO_TP | 15 | 16 | PEO_RP |
| | PEO_TN | 17 | 18 | PEO_RN |
| | GND | 19 | 20 | GND |

¹ Supply voltages from carrier board, switched on/off according to sleep state
² Stuffing option, no feed through by default



P-PCIE

Additional Functions

Firmware Hub 2

The C23-SATA is optionally provided with a 82802 compatible 8Mbit Flash (Firmware Hub), which can be used either as alternative boot BIOS, as an expansion memory to the CPU board BIOS, or for BIOS retrieval/rescue. The Firmware Hub is connected to the LPC (Low Pin Count) interface. The device ID of a particular FWH determines whether it is detected as BIOS after power on (ID = 0). If stuffed, the jumper J-FWH sets the on-board FWH2 ID to zero (and simultaneously changes the CCG-RUMBA SPI Flash BIOS ID to 1) - hence the system will use the BIOS on the C23-SATA after power-on.

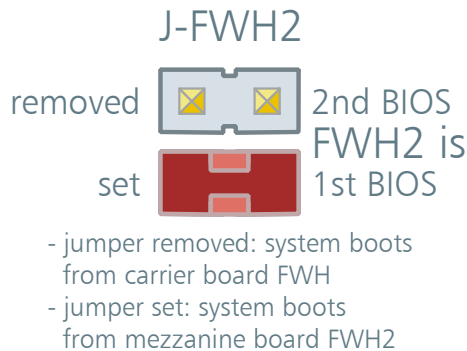

A programming tool for the Firmware Hub and latest BIOS releases can be obtained from the EKF website.

SMBus EEPROM

The C23-SATA is provided with a 24C01 1Kbit I²C EEPROM, for storing board configuration data. The EEPROM is accessed via the SMBus. If there is need for storing additional customer data, EKF can place an EEPROM instead with custom specific data space, e.g. 24C16.

If required, the SMBus EEPROM A1 can be optionally controlled (stuffing option) by SIO GP34 (serial port 4 DTR#), and the SMBus EEPROM WP is likewise tied to GP67 (serial port 4 RTS4#).

Trusted Platform Module

The C23-SATA can be optionally equipped with a Trusted Platform Module cryptographic chip according to the TPM 1.2 specification. The board provides a universal footprint which is suitable for

- ▶ SLB9635 (Infineon www.infineon.com/tpm)
- ▶ AT97SC3203 (Atmel www.atmel.com)

and other brands. The TPM chip communicates with the CPU carrier board through the LPC interface. Recent operating systems such as Windows Vista and Linux provide TPM software support.

Typically, TPM chip manufacturers provide the necessary device driver software for integration into special operating systems, along with BIOS drivers. Full documentation for TCG primitives can be found in the TCG TPM Main Specification, Parts 1 – 3, on the TCG website located at <https://www.trustedcomputinggroup.org/>. TPM features specific to PC Client platforms are specified in the “TCG PC Client Specific TPM Interface Specification, Version 1.2”, also available on the TCG web site. Implementation guidance for 32-bit PC platforms is outlined in the “TCG PC Client Specific Implementation Specification for Conventional BIOS for TCG Version 1.2”, also available on the TCG web site.

Atmels TPM includes a cryptographic accelerator capable of computing a 2048-bit RSA signature in 500 ms and a 1024-bit RSA signature in 100ms. Performance of the SHA-1 accelerator is 50us per 64-byte block. TCG key generation operations will be completed using a proprietary mechanism in less than 1 msec. The TPM is offered to OEM manufacturers as a turnkey solution, including the firmware integrated on the chip.

Infineons security controllers have achieved the industry's highest rating for digital security, the Common Criteria EAL 5 high Certificate issued by the German government agency responsible for security in information technology. Infineon provides OEMs with a complete TCG solution that includes all required hardware, software, and management utilities to develop a complete platform security solution.

Schematics

Complete circuit diagrams for this product are available for customers on request. Signing of a non-disclosure agreement would be needed. Please contact sales@ekf.de for details.

EKF reserves the right to refuse distribution of confidential information material for any reason that EKF may consider substantial.

EKF Elektronik GmbH
Philipp-Reis-Str. 4
59065 Hamm
Germany



Fax. +49 (0)2381/6890-90
Tel. +49 (0)2381/6890-0
Internet www.ekf.com
E-Mail info@ekf.de